

USER'S GUIDE

PORTER



230V



50/60Hz



110W



IP64



90° C



- 1_ **PRODUCT DESCRIPTION**
- 2_ **TECHNICAL FEATURES**
- 3_ **SIZES**
- 4_ **CERTIFICATIONS**
- 5_ **USER'S AND MAINTENANCE GUIDE**
- 6_ **RECYCLING**
- 7_ **DISPOSAL**
- 8_ **WARRANTY ON MANUFACTURING DEFECTS**

www.polibox.com

Publication 2012 – rel.02

Data, descriptions, and illustrations in this publication are for informational purpose and may be amended without prior notice.

1_ PRODUCT DESCRIPTION

Porter Activ is an **ACTIVE** isothermal box, with electric heating system for the thermal holding of foodstuff.

Made of expanded polypropylene (EPP), it is designed to protect the food from thermal stresses due to the insulating properties of the expanded polymer, which has a resistivity coefficient (Lambda) of 0,039 W/mk and ensures a thermal drop according to standard UNI EN 12571.

The active heating system allows to prolong the efficiency of the isothermal box, increasing the time where the contained product reaches the minimum temperature (65°C) compared to a passive box.

The resistance is thermostatic at an operating temperature of 90°C.

2_ TECHNICAL FEATURES

The polypropylene is expanded with CO₂, without CFC and HCFC and doesn't have residual expansion agents. It has a closed-cell structure, which gives excellent energy dissipation characteristics with shock and specific thermal resistance.

Polypropylene foam has an excellent environmental balance and doesn't cause environmental damages either due to production effect or as raw material, because:

- it consists mainly of air (with regard to the density it can reach 98% air) and only 2% of pure structural hydrocarbon material.
- it is 100% recyclable and at infinite cycles without the release of waste into the environment or loss of physical-chemical characteristics.
- it is a stable plastic polymer of hydrogen and carbon.
- Operating temperature -40° + 120°C

On the wall opposite to the opening there is a stainless steel plate, electrical resistance connected with a power of 110 W.

The electrical supply is ensured by a cable with a length of 2 m, connectable to the box. The indicators Led for the electric current supply presence and temperature reaching are present.

MAIN COMPONENTS:

1. Expanded polypropylene box
2. Hot plate
3. Siliconated resistance
4. Thermostat 90°C
5. Safety thermal fuse at 100°C
6. Feeder cable
7. Plug
8. Red current supply signalling led
9. Green resistance supply signalling led

ACCESSORY COMPONENTS:

1. Stainless steel carriage
2. Eutectic plate
3. Politherm GN 1/1 with grid
4. Digital thermometer -50/+150 °C
5. Portable car inverter





WIRING DIAGRAM

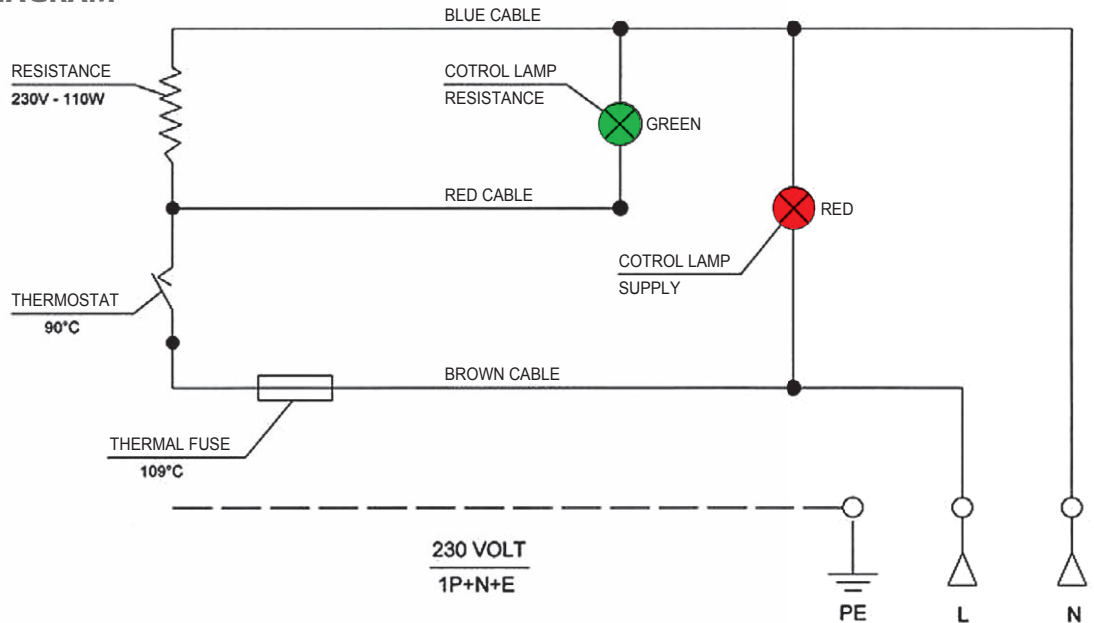

THERMOSTAT PROGRAMMED AT 90°C
SAFETY THERMAL FUSE AT 100°C

3_ SIZES

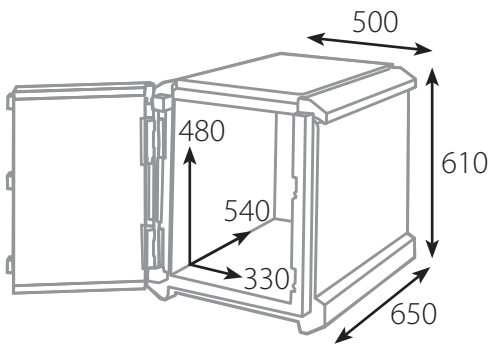

4_ CERTIFICATIONS

The Polibox[®] products present the following certifications obtained at the Experimental Station of Industry for canned food in Parma (SSICA):

- Migration test with short contact
- Migration test with prolonged contact
- Thermal decay test
- Cold-hot decay
- Decay under freezing

The product is in compliance with the following standards:

- Electromagnetic compatibility EN 55014-1 / EN 55014-2
- Electric components safety EN 60335-1 / EN 50106
- CE
- RoHS

12 guide guides.



2 x GN 1/1
200 mm

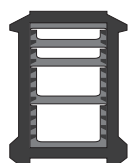

2 x GN 1/1
65 mm
1 x GN 1/1
100 mm
1 x GN 1/1
150 mm



4 x GN 1/1
100 mm

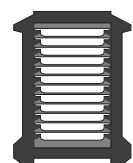

12 x GN
trays





LOCATION OF COMPONENTS

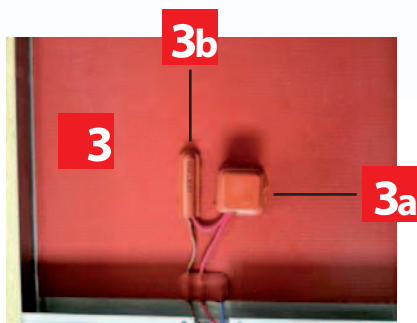
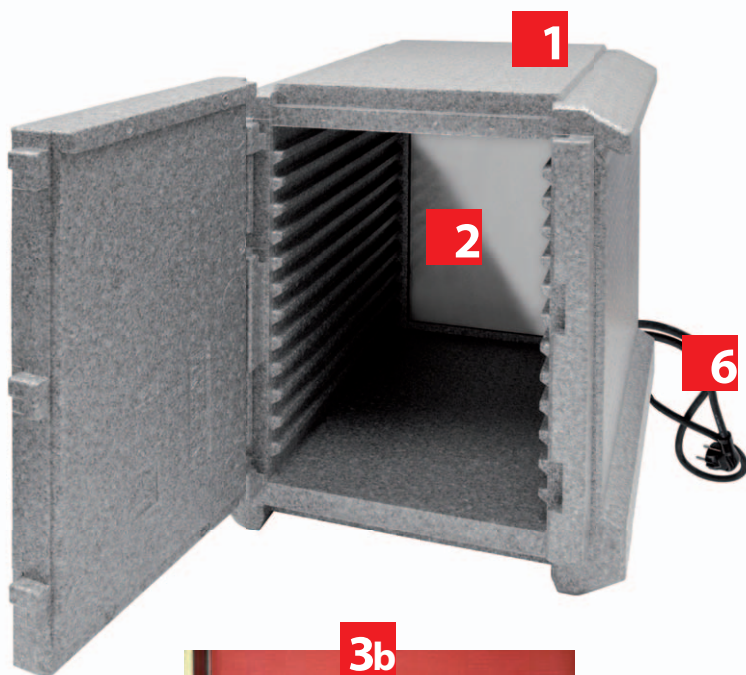

Resistance placed behind the steel plate pos. 2

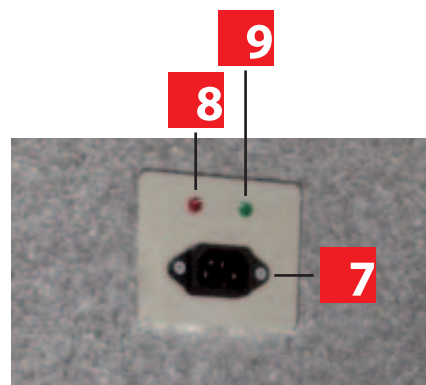

Back side

Pos	Description	Trademark	Model	Q.ty
1	Expanded polypropylene box	SDS srl	PORTER GN 1/1 ACTIV	1
2	Steel plate	SDS srl	AISI 304 – 12/10	1
3	Ultra-flat silicone resistance	Sedes Group	230V 110W Isolam.>10Mohm – IP64	1
*3a	Thermostat	R&D Components srl	KSD 301-RA-NC for resistance	1
*3b	Thermal fuse	Sung Woo	SW 1T for resistance	1
6	Feeder cable	Ningbo Qiaopu Electric Co. Ltd	Section 3x1 2 m with schuko outlet and connector IEC	1
7	Plug	Jackson Electronics Industrial Corp.	10A 230 VAC	1
8	Current supply led	Everel Group spa	Red d. 6 mm 230 VAC	1
9	Resistance supply led	Everel Group spa	Green d. 6 mm 230 VAC	1

*) the thermostat and the thermal fuse are protected by silicone covering





5_ USER'S AND MAINTENANCE GUIDE

The correct application of the following standards of use is necessary to hold the thermal functioning of the product, both for operators' safety as well as for the environments where it is used.

STANDARDS FOR ELECTRICAL SAFETY

Porter Activ is an electric appliance and for its use it is necessary to observe some basic precautions concerning safety. Therefore it is necessary to read carefully the following instructions of use.



- Introduce the supply cable outlet to the box, ensuring that the connection plug is completely dry.
- Connect the plug to an earth connected current outlet.
- The green led and the red led are switched on:
Red led > current supply,
Green led > supply to the resistance (when the resistance reaches the temperature, the green led switches off).

NOTE: call technical assistance, if the green led doesn't switch on when connecting the feeder cable.

- Don't touch the hot parts of the box (wall opposite the opening one).
- Be extremely careful when there is oil or other boiling liquids inside the box.
- Don't use the box for uses different from the original one.
- Don't immerse the cable, the plug or the box in water or other liquid in order to be protected against electric shocks; avoid the use of water splashes when connected to the network.
- Avoid the use of accessories, not recommended by SDS
- In order to reduce the risk of personal injuries, disconnect the cable from the feeding net when:
 - the box isn't used
 - during handling operations
 - during cleaning, maintenance, repair operations
- The feeder cable has always to be whole, may not come in contact with hot parts or with oil, may not be connected on the edge of a table or touch boiling surfaces.
- Don't place the appliance on or near an electric, gas or hot oven.
- If the feeder cable of this unit is damaged, it should be replaced by the manufacturer, by an authorized centre or by qualified staff.

IMPORTANT: if the capsuled plug is damaged, replace it immediately. It is not possible to introduce new cables in the plug and this could cause electric discharges if introduced in an outlet.

TERMS OF USE

The isothermal box Porter Activ should be used to keep products at a controlled temperature, and it is easily transportable. The isothermal box should not be used directly in ovens or cookers. Heat-sensitive and thermal perishable products in special packages or hygienic pre-wrapped, trays or welded plates, gastronomic dishes of steel, polycarbonate or polypropylene can be placed in the box.

Regarding the "hot bond" it is recommended to supply the box electrically for at least 30 minutes before its use and to keep it supplied till the moment of transport.

Before using the Porter Activ for the first time, wash the box, including the lid, according to the procedure noted in paragraph Cleaning instruction. It is recommended to place it on a clean flat surface. The heat-sensitive and thermal perishable products have to be placed in special cases, which allow the closure in order to prevent spillage or leakage of substances. Place the special cartons in the Polibox[®], taking care to fill the entire base area and to distribute the weight evenly; close the Polibox[®] with the appropriate lid. In order to ensure the correct thermal seal function, it is necessary that the Polibox[®] remains closed with the proper lid from the packaging until product delivery.





Temperature: the products placed inside the Porter Activ shouldn't have a higher temperature than 100 °C. A digital thermometer (optional) can be applied to the Polibox[®] for temperature control. Observe the requirements of standard UNI EN 12571 for the correct temperature maintenance.

Handling and transport: due to the type and thickness of the material, the box is lightweight, without sharp edges and protrusions, both to protect the safety of the operators during handling and transport, as well as to avoid accumulation of dirt in the corners. However, it is recommended to use proper hand trolleys; it is possible to use the optional trolley. In general you should observe the company procedures for the correct handling of loads.

Food safety: polypropylene is a material, suitable for contact with food substances. It doesn't release either smell, or taste to foods and it can be easily washed and sanitized after use. The boxes Porter Activ are suitable to protect the food against thermal stresses, due to the insulating properties of the polymer foam, which has a coefficient of resistivity (λ) of 0.039 W / mk and ensures a thermal loss according to standard UNI EN 12571.

Cleaning instructions:



ATTENTION:

Disconnect the product from the network before cleaning the plate.

Don't clean the hot plate under running water or pour a liquid product on it, but use a wet cloth, both for the inner and outer box surface.

The isothermal box can be washed and sanitized in a dishwasher, in industrial cleaning centres, with direct water jet, with high-pressure machines, with steam machines (up to 100°C) or by hand. All detergents and disinfectants can be used for the cleaning provided they don't contain products derived from petrol and trichloroethylene. It is recommended to wash the box both internally and externally in order to ensure a perfect hygiene level. Very important: the box has to be completely dry after washing; the drying has to be carried out with overturned and open box.

Reaction to fire: the isothermal box has a 1 class fire reaction and has to be kept away from open fire. It cannot be exposed to higher temperatures than 100°C.

6_ RECYCLING

The boxes, once separated from the metallic and electric part, can be collected at recycling plants and milled. The boxes can be collected in recycling plants and be grounded. The resulting product is normally used to produce new packaging or products that are used in the building industry like lightening components. The box is 100% recyclable.

7_ DISPOSAL

The metallic part and the electric cabling have to be separated from the polypropylene for disposal. The plate is disposed with metal, the electric part with the electric-electronic ones. The boxes are disposed in the plastic. Polypropylene incinerated at higher temperatures than 900 °C, has carbon dioxide (CO₂) and water (H₂O) as residues released into the atmosphere. The product is chemically inert, it doesn't pollute either the air or groundwater.

7_ WARRANTY ON MANUFACTURING DEFECTS

With the exclusion of any legal claim, SDS Ltd. provides free of charge repair or replacement within the warranty period of the law to all the defect found parts, provided it is shown, that the defect is not derived from uses different from the ones described in this manual, from overuse or from use contrary to the detailed instructions in the preceding paragraphs. The warranty is strictly limited to the repair or replacement of parts supplied by us and doesn't accept any claims based on damages to people, property or loss of production.